

# Analog Devices Welcomes Hittite Microwave Corporation

NO CONTENT ON THE ATTACHED DOCUMENT HAS CHANGED



**THIS PAGE INTENTIONALLY LEFT BLANK**



## GaAs MMIC SMT PASSIVE FREQUENCY DOUBLER, 2 - 4 GHz INPUT

### Typical Applications

The HMC189AMS8(E) is suitable for:

- Wireless Local Loop
- LMDS, VSAT, and Point-to-Point Radios
- UNII & HiperLAN
- Test Equipment

### Features

- Conversion Loss: 13 dB
- Fo, 3Fo, 4Fo Isolation: 33 dB
- Input Drive Level: +10 to +15 dBm

### Functional Diagram

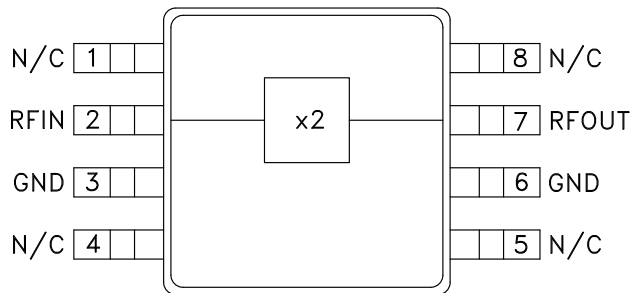

### General Description

The HMC189AMS8(E) is a miniature passive frequency doublers in plastic 8-lead MSOP packages. The suppression of undesired fundamental and higher order harmonics is 33 dB typical with respect to input signal levels. The doubler uses the same diode/balun technology used in Hittite MMIC mixers. The doubler is ideal for high volume applications where frequency doubling of a lower frequency is more economical than directly generating a higher frequency. The passive Schottky diode doubler technology contributes no measurable additive phase noise onto the multiplied signal.

### Electrical Specifications, $T_A = +25^\circ C$ , As a Function of Drive Level

Parameter	Input = +10 dBm			Input = +13 dBm			Input = +15 dBm			Units
	Min.	Typ.	Max.	Min.	Typ.	Max.	Min.	Typ.	Max.	
Frequency Range, Input	2.5 - 3.5			2.5 - 3.75			2 - 4			GHz
Frequency Range, Output	5 - 7			5 - 7.5			4 - 8			GHz
Conversion Loss		13	17		13	15		13	17	dB
FO Isolation (with respect to input level)	29	32		30	33		31	34		dB
3FO Isolation (with respect to input level)	37	43		35	42		33	40		dB
4FO Isolation (with respect to input level)	32	40		33	40		31	40		dB

## GaAs MMIC SMT PASSIVE FREQUENCY DOUBLER, 2 - 4 GHz INPUT

**Conversion Loss @ +13 dBm Drive Level**

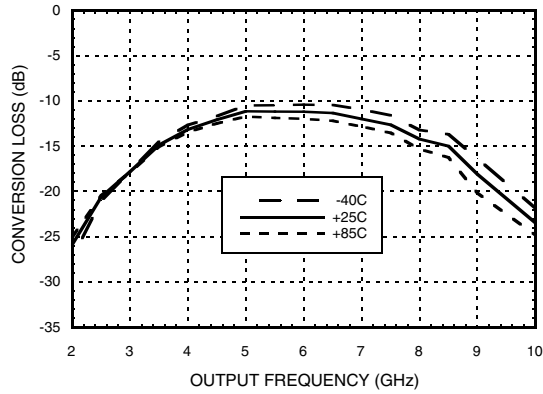

**Isolation\* @ +13 dBm Drive Level**

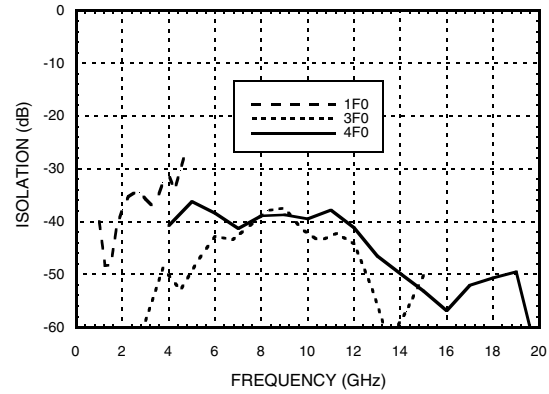

\* With respect to input level

**Conversion Loss vs. Drive Level**

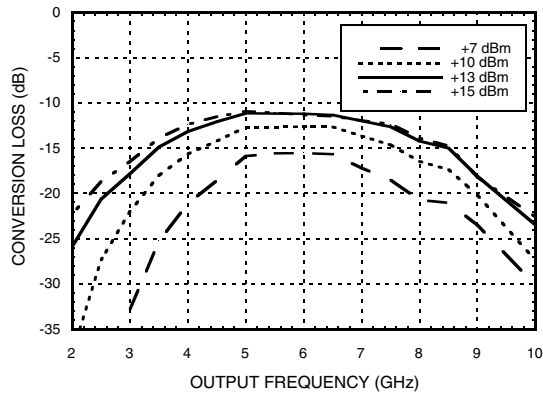

**Isolation\* @ +10 dBm Drive Level**

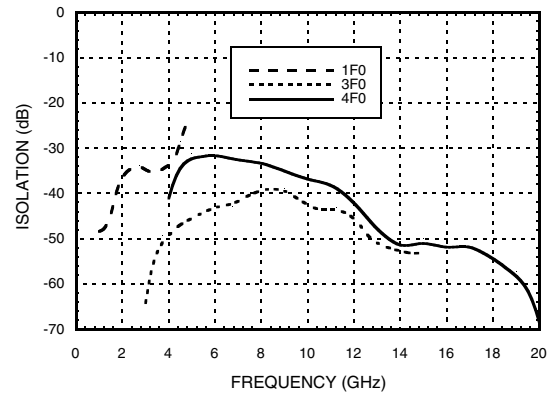

\* With respect to input level

**Input Return Loss vs. Drive Level**

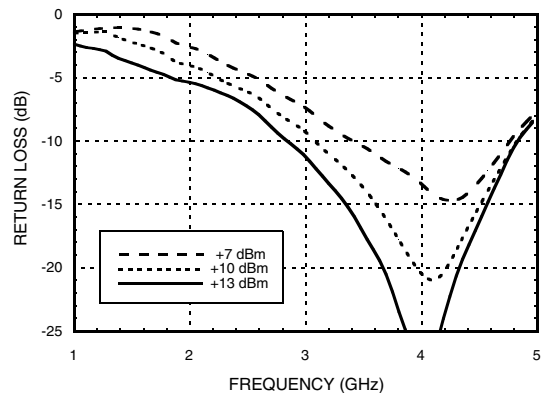

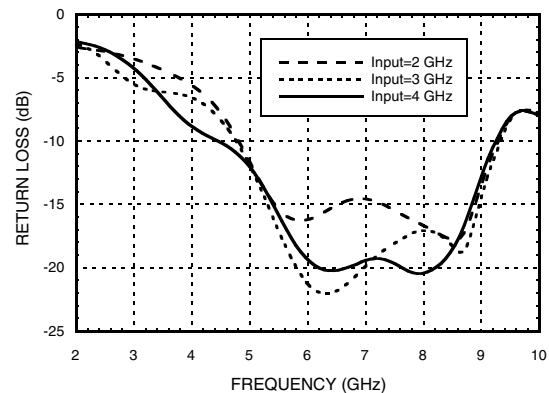

**Output Return Loss for Several Input Frequencies**

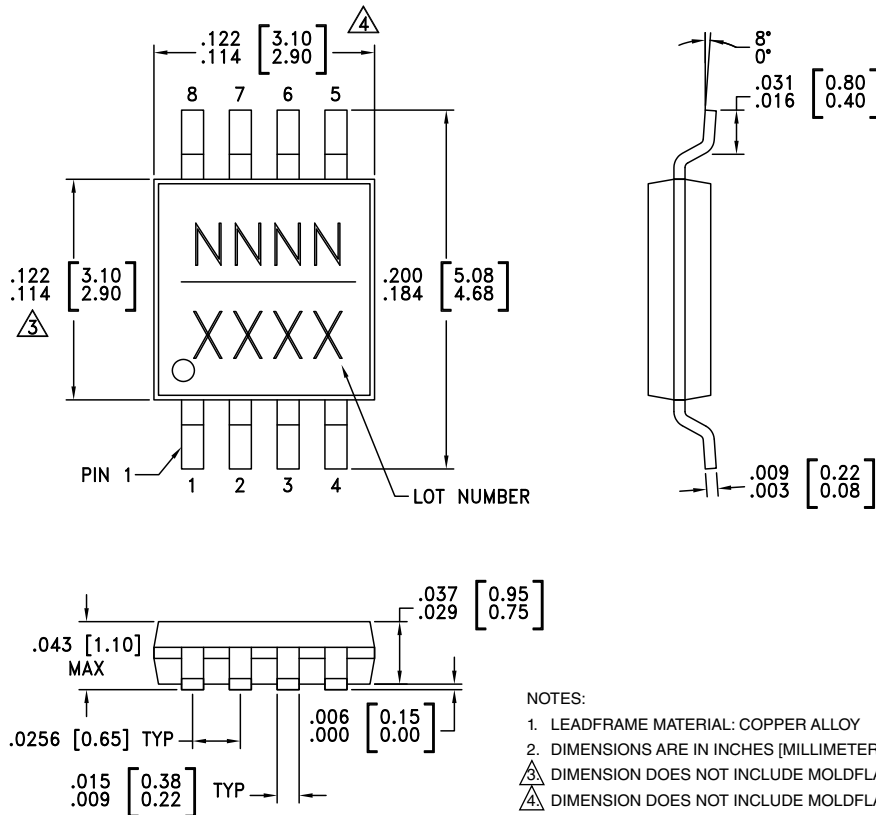

**Absolute Maximum Ratings**

Input Drive	+27 dBm
Storage Temperature	-65 to +150 °C
Operating Temperature	-40 to +85 °C
ESD Sensitivity (HBM)	Class 1B

**ELECTROSTATIC SENSITIVE DEVICE  
OBSERVE HANDLING PRECAUTIONS**
**Outline Drawing**

**NOTES:**

- LEADFRAME MATERIAL: COPPER ALLOY
- DIMENSIONS ARE IN INCHES [MILLIMETERS].
-  DIMENSION DOES NOT INCLUDE MOLDFLASH OF 0.15mm PER SIDE.
-  DIMENSION DOES NOT INCLUDE MOLDFLASH OF 0.25mm PER SIDE.
- ALL GROUND LEADS MUST BE SOLDERED TO PCB RF GROUND.

**Package Information**



Part Number	Package Body Material	Lead Finish	MSL Rating	Package Marking <sup>[3]</sup>
HMC189AMS8	Low Stress Injection Molded Plastic	Sn/Pb Solder	MSL1 <sup>[1]</sup>	189A XXXX
HMC189AMS8E	RoHS-compliant Low Stress Injection Molded Plastic	100% matte Sn	MSL1 <sup>[2]</sup>	189A XXXX

[1] Max peak reflow temperature of 235 °C

[2] Max peak reflow temperature of 260 °C

[3] 4-Digit lot number XXXX

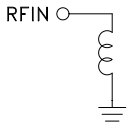
**Pin Description**

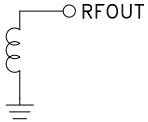
Pin Number	Function	Description	Interface Schematic
1, 4, 5, 8	N/C	These pins are not connected internally; however, all data shown herein was measured with these pins connected to RF/DC ground externally.	
2	RFIN	Pin is DC coupled and matched to 50 Ohms from 2.0 to 4.0 GHz	
3, 6	GND	All ground leads must be soldered to PCB RF/DC ground.	
7	RFOUT	Pin is DC coupled and matched to 50 Ohms from 4.0 to 8.0 GHz	

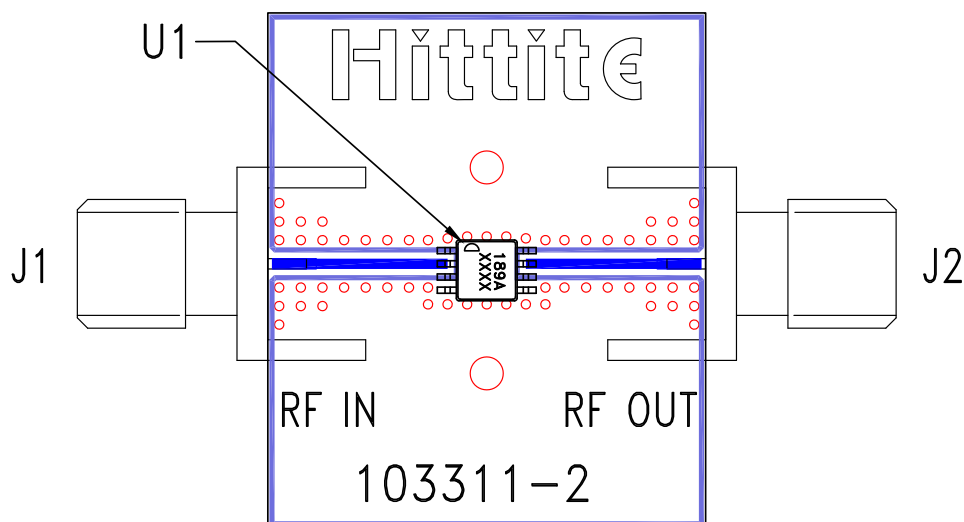
**Evaluation PCB**

**List of Materials for Evaluation PCB 103313 <sup>[1]</sup>**

Item	Description
J1, J2	PCB Mount SMA Connector
U1	HMC189AMS8(E) Doubler
PCB [2]	103311 Eval Board

[1] Reference this number when ordering complete evaluation PCB

[2] Circuit Board Material: Rogers 4350

The circuit board used in the application should be generated with proper RF circuit design techniques. Signal lines at the RF port should have 50 ohm impedance and the package ground leads should be connected directly to the ground plane similar to that shown above. The evaluation circuit board shown above is available from Hittite Microwave Corporation upon request.